

stanton

DJLab 2.1 Complete DJ System

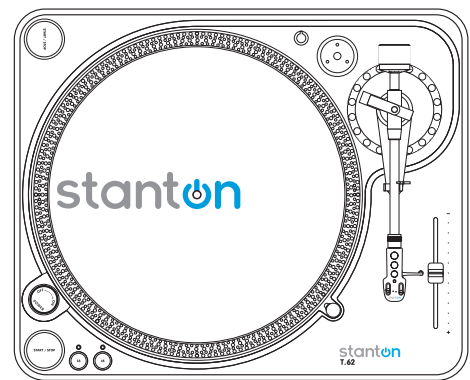
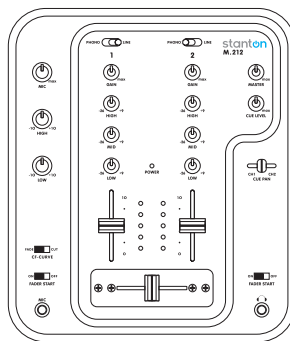
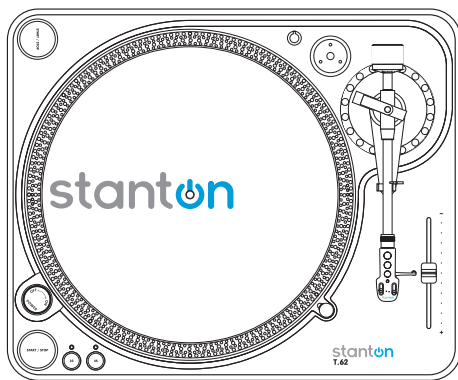

USER'S MANUAL

IMPORTANT SAFETY PRECAUTIONS

1. **Read Instructions** – All the safety and operating instructions should be read before this product is operated.
2. **Retain Instructions** – The safety and operating instructions should be retained for future reference.
3. **Heed Warnings** – All warnings on the appliance and in the operating instructions should be adhered to.
4. **Follow Instructions** – All operating and use instructions should be followed.
5. **Water and Moisture** – The appliance should not be used near water - for example, near a bathtub, washbowl, kitchen sink, laundry tub, in a wet basement, or near a swimming pool, and the like.
6. **Heat** – Appliance should be situated away from heat sources such as radiators, heat registers, stoves, or other appliances (including amplifiers) that produce heat.
7. **Power Sources** – This product should be operated only from the type of power source indicated on the rating label. If you are not sure of the type of power supply to your home, consult your product dealer or local power company. For products intended to operate from battery power, or other sources, refer the operating instructions.
8. **Grounding or Polarization** – This product may be equipped with a polarized alternation-current line plug (a plug having one blade wider than the other). This plug will fit into the power outlet only one way. This is a safety feature. If you are unable to insert the plug fully into the outlet, try reversing the plug. If the plug should still fail to fit, contact your electrician to replace your obsolete outlet. Do not defeat the safety purpose of the polarized plug.
9. **Power-Cord Protection** – Power-supply cords should be routed so that they are not likely to be walked on or pinched by items placed upon or against them, paying particular attention to the cord in correspondence of plugs, convenience receptacles, and the point where they exit from the appliance.
10. **Cleaning** – The appliance should be cleaned only as recommended by the manufacturer. Clean by wiping with a cloth slightly damp with water. Avoid getting water inside the appliance.
11. **Non-use Periods** – The power cord of the appliance should be unplugged from the outlet when left unused for a long period of time.
12. **Object and Liquid Entry** – Care should be taken so that objects do not fall and liquids are not spilled into the enclosure through openings.
13. **Damage Requiring Service** – The appliance should be serviced by qualified service personnel when:
 - A. The power-supply cord or the plug has been damaged; or
 - B. Objects have fallen, or liquid has been spilled into the appliance; or
 - C. The appliance has been exposed to rain; or
 - D. The appliance does not appear to operate normally or exhibits a marked change in performance; or
 - E. The appliance has been dropped, or the enclosure damaged.
14. **Servicing** – The user should not attempt any service to the appliance beyond that described in the operating instructions. All other servicing should be referred to qualified service personnel.
15. **Ventilation** – Slots and openings in the cabinet are provided for ventilation and to ensure reliable operation of the product and to protect it from overheating, and these openings must not be blocked or covered. The openings should never be blocked by placing the product on a bed, sofa, rug, or other similar surface. This product should not be placed in a built-in installation such as a bookcase or rack unless proper ventilation is the manufacturer's instructions have been adhered to.
16. **Attachments** – do not use attachments not recommended by the product manufacturer as they may cause hazards.
17. **Accessories** – Do not place this product on an unstable cart, stand, tripod, bracket, or table. The product may fall, causing serious injury to a child or adult, and serious damage to the product. Use only with a cart, stand, tripod, bracket, or table recommended by the manufacturer, or sold with the product. Any mounting of the product should follow the manufacturer's instructions, and should use a mounting accessory recommended by the manufacturer.
18. **Replacement Parts** – When replacement parts are required, be sure the service technician has used replacement parts specified by the manufacturer or have the same characteristics as the original part. Unauthorized substitutions may result in fire, electric shock, or other hazards.
19. **Safety Check** – Upon completion of any service or repairs to this product, ask the service technician to perform safety checks to determine that the product is in proper operating conditions.
20. **This product is in compliance with EU WEEE regulations.** Disposal of end of life product should not be treated as municipal waste. Please refer to your local regulations for instructions on proper disposal of this product.
21. **Carts and Stands** – The appliance should be used only with a cart or stand that is recommended by the manufacturer. An appliance and cart combination should be moved with care. Quick stops, excessive force, and uneven surfaces may cause the appliance and cart combination to overturn.



CAUTION

RISK OF ELECTRIC SHOCK
DO NOT OPEN



CAUTION: To reduce the risk of electric shock, do not remove any cover. No user-serviceable parts inside. Refer servicing to qualified service personnel only.



The lightning flash with arrowhead symbol within the equilateral triangle is intended to alert the user to the presence of un-insulated "dangerous voltage" within the product's enclosure that may be of sufficient magnitude to constitute a risk of electric shock.



The exclamation point within the equilateral triangle is intended to alert the user to the presence of important operation and maintenance (servicing) instructions in the literature accompanying this appliance.

CAUTION: To prevent electric shock, do not use this polarized plug with an extension cord, receptacle or other outlet unless the blades can be fully inserted to prevent blade exposure.

M.212 INTRODUCTION

Thank you for purchasing Stanton's newest innovation in professional tabletop mixer. The M.212 mixer was designed to bring style and reliability to the mobile or club DJ at an affordable cost.

M.212 MAIN FEATURES

- 2 bend EQ w/ input GAIN control per channel.
- Fader Start
- Power on/off muting
- Long Life crossfader
- Crossfader curve control

M.212 ACCESSORIES

Checking Package Contents

Check that the carton contains the following items:

- (1) M.212 Mixer
- (2) AC adaptor
- (3) User's Manual

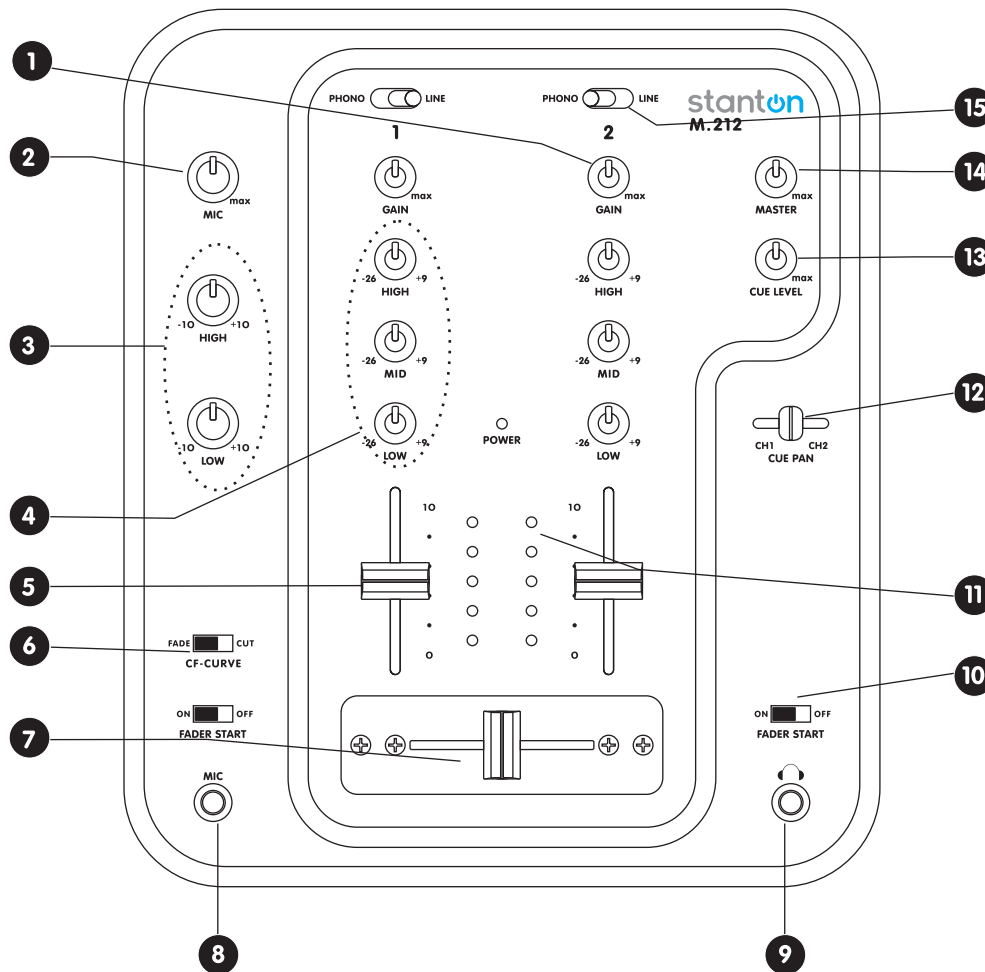

1. Channel Gain - Adjusts the pre-fader volume for cleaner sound. Reduce the channel gain if you notice the level indicators flashing red.

2. Mic Input Gain - Adjusts microphone input level.

3. Mic EQ - The mic channel includes a two-band EQ with a range of +10dB to -10dB.

4. Channel EQ - Adjusts the high, mid and low frequency levels of the input channels for either making the treble or bass louder or to be used as an effect.

5. Input Fader - Controls individual source levels (channels) in the mix.

6. Crossfader Curve - The CUT setting allows the use of the crossfader for quick cut in and out when scratching and mixing. The FADE setting is used for longer segues, typically when mixing between two beat-matched sources.

7. Crossfader - Used to mix the sound from both channels.

8. Mic Input - Insert your 1/4" microphone plug here.

9. Headphone Input - Insert your 1/4" headphone plugs here.

10. Fader Start On/Off Switch - When the unit has been connected to a CD player using a control cable, this becomes the On/Off switch to automatically start and stop the CD player while using the crossfader.

11. Level Indicators - The dual LED indicators are used to indicate the master output level of the Right and Left channels.

12. Channel Cue / Cue Pan - Used to preview channel audio to your headphones. Listen here before bringing up channel faders or moving the crossfader.

13. Headphone Level - Adjusts cue volume.

14. Master Level - Controls the overall output level.

15. Input Toggle Switch - Selects which source will be active based on what you have connected to the rear panel input section (phono/line).

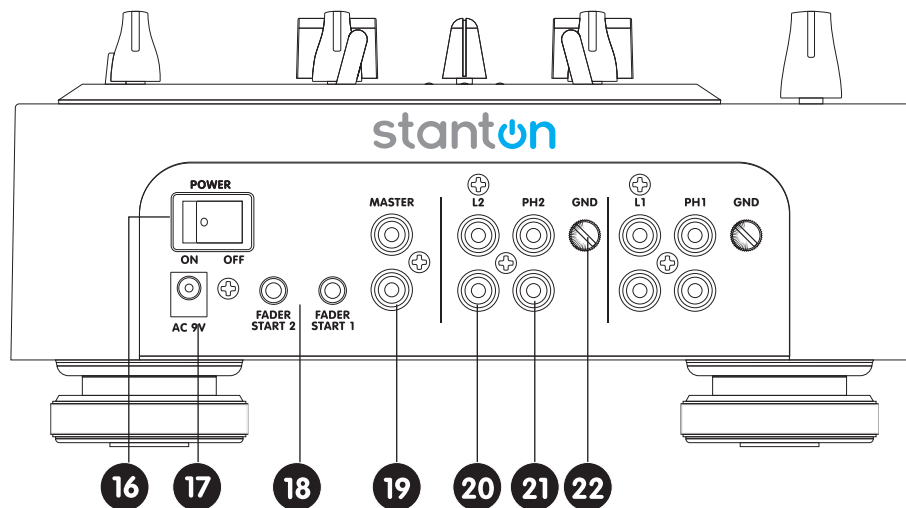

16. Power Switch - Turns unit off and on.

17. Power Connector - Plug in the included power supply here.

18. Fader Start Control Jacks - Connect these jacks to the Fader input jacks of the CD player using the 3.5mm stereo mini cord.

19. Master Output - Unbalanced RCA connectors controlled by the Master level.

20. Line Inputs - Unbalanced RCA jacks for connecting stereo audio from line level sources such as CD players, HiFi VCRs, cassette decks, DAT machines, laser discs, tuners, even synthesizers or other mixing consoles. Note: Plug mono audio sources into both Left and Right inputs using a "Y" cable connector.

21. Phono Inputs - Plug your turntables in here. When these connectors are used, your signal is fed directly to the high-quality RIAA phono pre-amplifiers. Use this position only for turntables. Line level sources will overload the sensitive phono preamps and will cause distortion.

22. GND - Connect each of your turntable ground leads to either of the two ground terminals.

M.212 QUICK SETUP DIAGRAM

Review this setup diagram. Make sure all faders are at "zero" and all devices are off. First, connect all input sources and processors. Next, connect your microphone and monitor headphones. Finally, connect the stereo outputs to the power amplifier(s) and/or audio receivers such as tape decks. Plug your mixer into AC power. Now you are ready to switch everything on.

IMPORTANT: Always switch on your audio input sources, such as turntables or CD players first, then your mixer, and finally any amplifiers. When turning off, always reverse this operation by turning off amplifiers, then your mixer, and then input devices.

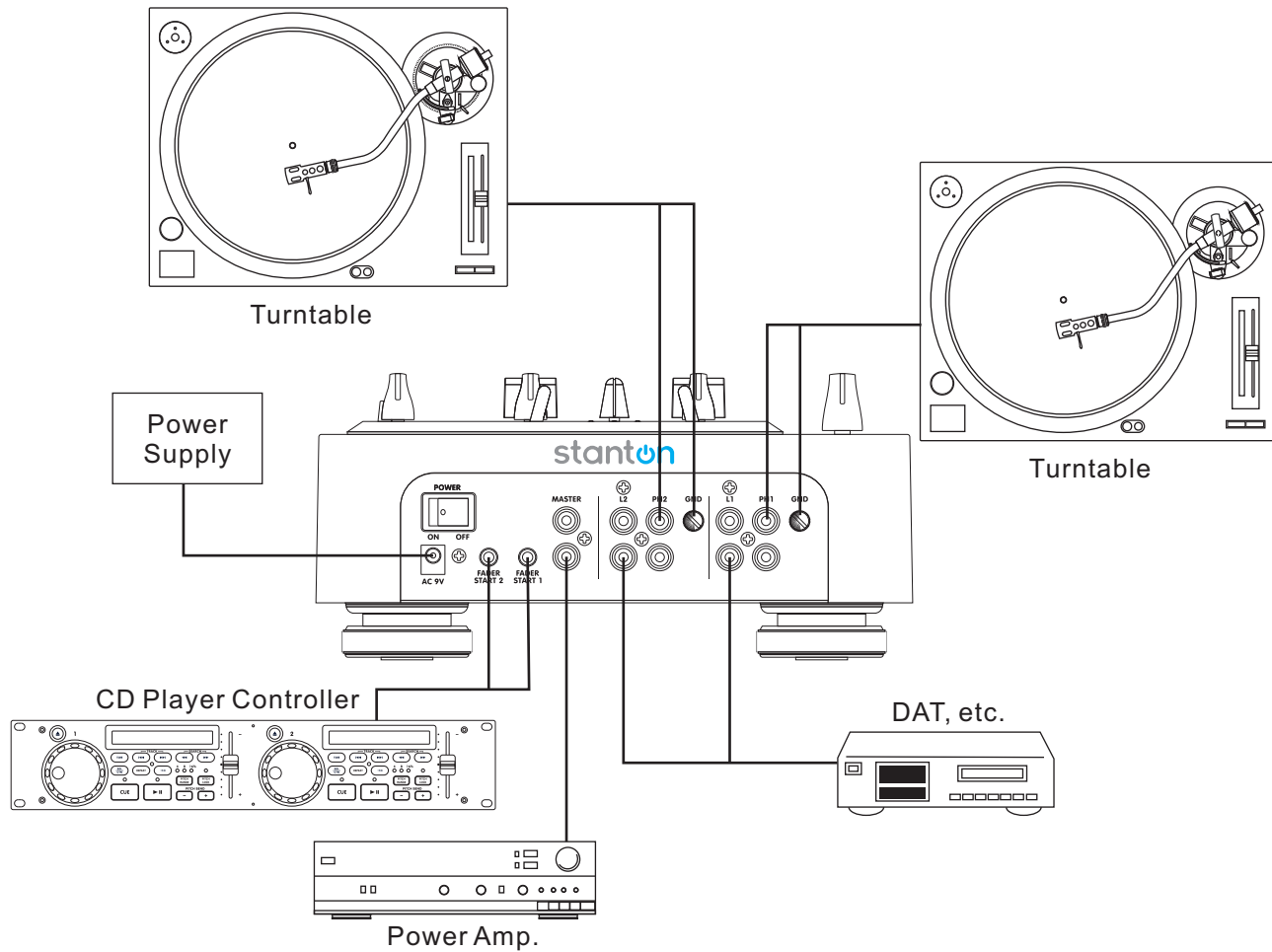

M.212 SPECIFICATIONS

Input / output impedance & sensitivity: (Master 0dBV output, load=100Kohm, Max. gain, EQ flat)

Line	10K ohm /-14dBV (200mV) +/-2dB
Phono	47K ohm /-50dBV (3.16mV) +/-2dB
Mic	2.2K ohm /-60dBV (1mV) +/-2dB
Master	1K ohm
Phones	33 ohm / 0dBV (1V) ±2dB

Max. output (THD=1%, Maximum gain, EQ flat)

Master	More than +18dBV (8.0V) at load=100K ohm
Phones	More than +4dBV (1.6V) at load=32 ohm

Channel balance Within 3dB

Frequency response: (Master output, EQ flat)

Line	20-20KHz +/- 2dB
Phono	20-20KHz+2, -3dB (RIAA)
Mic	20-20KHz+2/-3dB

S/N ratio: (Maximum gain, master 0dBV output, EQ flat, w/ 20KHz LPF, A-weighted)

Line	Less than -80dBV
Phono	Less than -70dBV
Mic	Less than -60dBV

THD + N: (Master 0dBV output, maximum gain, w/ 20KHz LPF)

Line	Less than 0.05% 20 - 20KHz
Phono	Less than 0.1% 20 - 20KHz (IEC-A WTD)
Mic	Less than 0.2% 20 - 20KHz (IEC-A WTD)
Phones	Less than 0.1% 20 - 20KHz (From line input)

Crosstalk: (From master output, A-weighted)

Line/Phono	More than 70dB at 1KHz between L and R
	More than 70dB at 1KHz between channels

MIC EQ

Hi	10 +/- 2dB at 10KHz
	-10 +/- 2dB at 10KHz
Low	10 +/- 2dB at 100Hz
	-10 +/- 2dB at 100Hz

Channel EQ

Hi	9 +/- 2dB at 13KHz
	-15 +/- 3dB at 13KHz
Mid	9 +/- 2dB at 1KHz
	Less than -23dB at 1KHz
Low	9 +/- 2dB at 70Hz
	-26 +/- 3dB at 70Hz

Power Source AC 9V,1000mA

Dimensions 230 (W) X 267 (D) X 111 (H) mm

Weight 1.65Kgs

T.62 ASSEMBLY

Thank you for purchasing the T.62 turntable from Stanton. The T.62 is built upon Stanton's heritage of designing audiophile products for the most discriminating listener. Before assembling the T.62 please check to make sure the following items are included with the main unit in the carton.

- AC cord
- RCA cable
- 45 rpm adaptor
- Counter weight
- Cloth dust cover
- Platter
- Slipmat
- Stanton 500.V3 Cartridge pre-mounted on headshell, except on model T.62X, no cartridge included
- User Manual
- Target light

After confirming that all of the above parts are included in the box, its time to assemble the turntable.

- 1) Remove the platter from its protective wrapping and place on the spindle of the main unit.
- 2) Remove the slipmat from its protective wrapping and place on the platter.
- 3) Place the counter-weight on the back of the tonearm assembly.
- 4) If desired place the 45rpm adaptor in its allocated holder on the main unit.

T.62 PLACEMENT

- Do not place the unit in a location where it will be exposed to direct sunlight or near a heating appliance.
- Do not place the unit in a location where there is high humidity or a lot of dust.
- Cartridge may pick up slight sound pressures or vibrations from the speakers coming along the floor or through the air resulting in feedback. Find a location which is very stable and vibration free.
- The legs have functions for adjusting the height of the unit itself. Adjust the legs to stabilize the main body horizontally.

T.62 CONNECTIONS

To properly connect your T.62, please follow these simple instructions:

1. Turn Off your equipment.
2. Connect the power cord to an AC outlet.
3. Connect the RCA cable from the T.62 Phono Output to your DJ Mixer Phono input.
4. Connect the ground cable from the T.62 ground post to your DJ Mixer ground terminal.

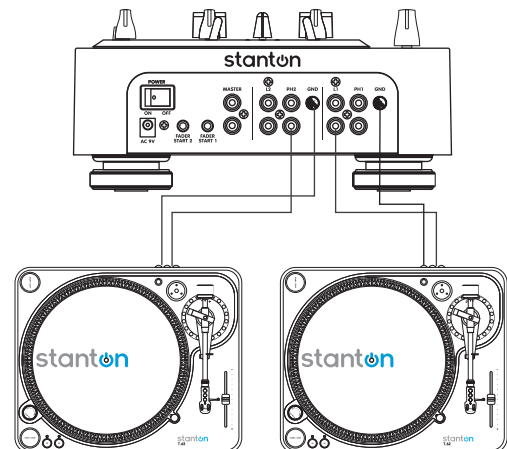

T.62 TONEARM AND CARTRIDGE SETTING

The major cause of problems in sound and skipping on the vinyl is the lack of proper set up of the needle and turntable adjustments. The needle is designed to operate at a specific angle to the vinyl. The T.62 has two adjustments to correctly position the needle to the vinyl.

1. The first adjustment is the installation of the cartridge-head-shell assembly into the tone arm tube lock. The T.62 includes a Stanton 500 V3 cartridge pre-mounted to the headshell. Holding the tone arm tube in one hand, insert the cartridge-headshell into the tube lock with the other hand. Turn the lock ring clockwise (when viewed from the rear) until the headshell is locked tightly into the tone arm. Remove the needle protector from the cartridge and place the needle on record. View the needle from the front and insure that the needle is perpendicular to the record surface. If some adjustment is needed, simply loosen the lock ring and rotate the cartridge headshell until the needle is perpendicular to the record surface. Then re-tighten the lock ring.

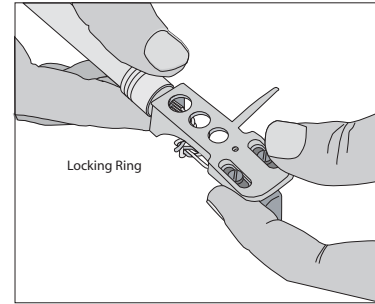

2. The second adjustment is the needle (or stylus) pressure. Start with the cartridge-headshell assembly mounted into the tone arm. Remove any needle protectors provided. With tone arm free, adjust the tone arm counterweight by rotating the rear section until the tone arm floats in a balanced condition above the record or mat. Do not allow the needle to drop onto the mat or the turntable platter during this adjustment. You might damage the needle tip. Now, carefully hold the tone arm in one hand while rotating the numbered ring on the front of the counter-weight with the other hand to the "0" setting. Next, without touching the numbered ring, Rotate the rear counterweight until the desired needle pressure reading is next to the line on top of the tone arm tube. The recommended stylus pressure for the Stanton 500 V3 cartridge is between two and five grams.

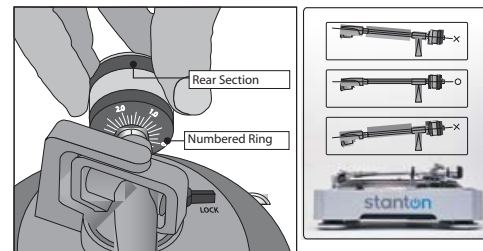

T.62 OPERATIONS

1. Rotate the power dial clockwise to turn on the power, the speed indicator and the strobe-illuminator will light up.
2. Place a record on the slip mat, when playing a 45rpm record with a large center hole, place the 45-rpm adaptor on the center spindle.
3. Set the rotation speed (33/45) to match the record.
4. Remove the stylus protector, release the arm clamp.
5. Press the Start/Stop button, the turntable platter will start to rotate.
6. Move the tonearm over the desired groove.
7. When play is finished, move the tonearm to the arm rest, secure the tonearm with the arm clamp.
8. Press the Start/Stop button to stop the platter rotating, rotate the power dial to turn off the power

T.62 MAINTENANCE

- For best results & proper care of your equipment use Stanton Vinyl Cleaner (VC-1) for your records and Stylus Cleaner Kit for styli (SC-4).
- Clean the stylus periodically with a soft brush to prevent the accumulation of dust.
- When the sound becomes distorted or noisy, check the stylus. If worn out, replace it with a new one.
- Any volatile materials such as alcohol, thinner, benzine, etc., may remove the paint or damage the paint finish, please avoid.

H* & CONTROL OVERVIEW

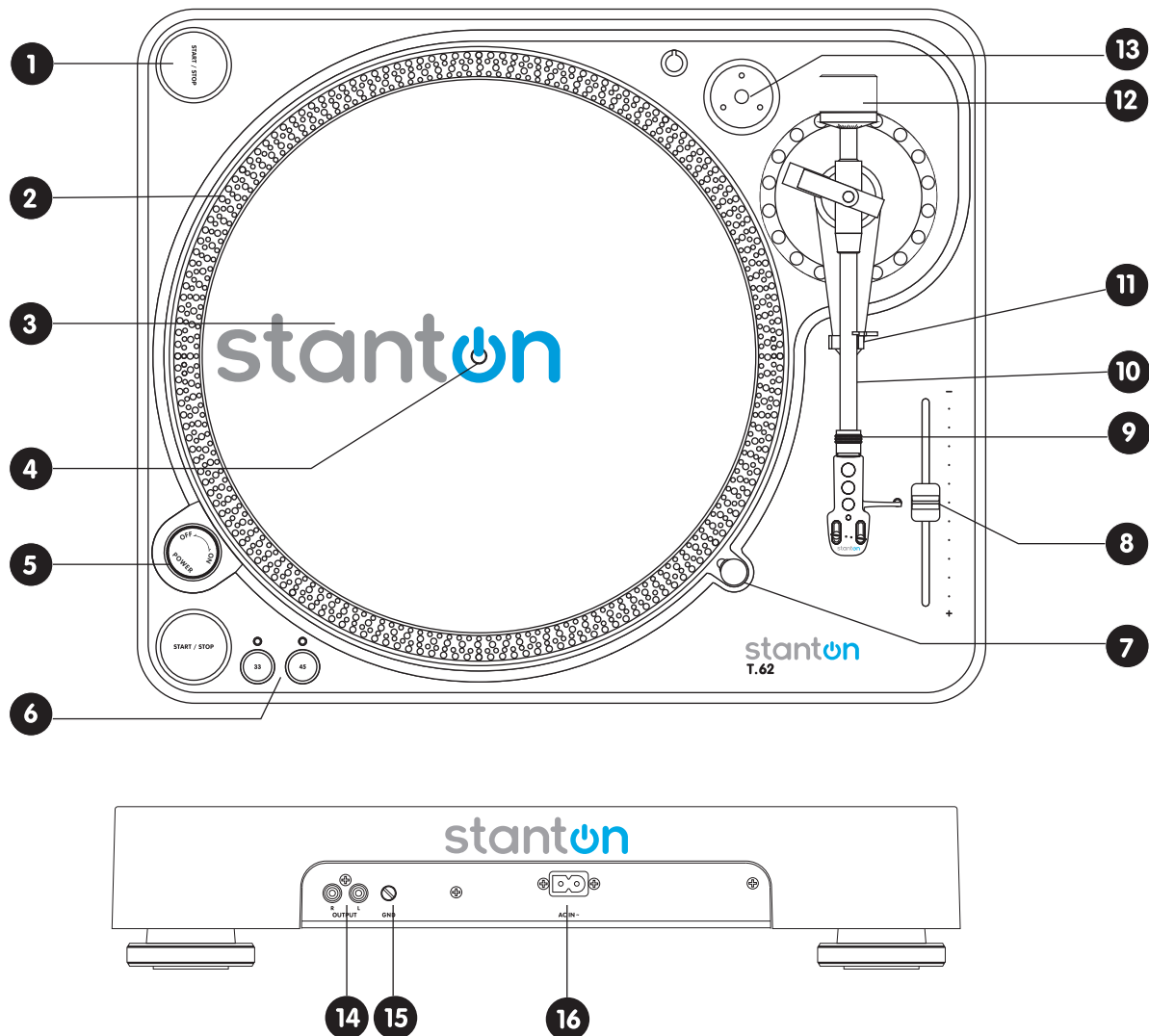

1. Start/Stop - Press this button to start or stop the platter.

2. Strobe dots - The dots around the edge of the platter are used in conjunction with the light located inside the motor ON/OFF switch. While the platter is in rotation, the dots help to indicate the speed of rotation. The speed is lower than the displayed speed (33,45,) when the dots are flowing to the right. It is higher than the displayed speed (33,45,) when the dots are flowing to the left. When the strobe is stopped, the platter is rotating at the displayed speed.

3. Slipmat

4. Center spindle

5. Power on/off
 - On - Rotate right
 - Off - Rotate left

6. Platter revolution speeds
 - 33 rpm Press 33
 - 45 rpm Press 45

7. Target light - Insert target light to the deck and it will light up.

8. Pitch slider - Use this to change the speed of the platter when the PITCH indicator is lit.

9. Headshell locking nut - Attach headshell by inserting into the front end of the tone arm, then turn the locking nut clockwise with the head shell firmly held horizontally.

10. Tonearm

11. Tonearm clamp and rest - Use this rest for the tone arm and clamp it in position during transportation.

12. Counterweight - Use this to balance the tonearm and to adjust the stylus pressure.

13. 45rpm adapter holder - Place the attached 45rpm adapter here.

14. Output L&R - This is the standard analog output (RCA jacks) which should be connected to a phono input on any DJ mixer.

15. GND - Ground.

16. Power cord connector - Used to connect the supplied power cord.

T.62 SPECIFICATIONS

GENERAL

Dimensions

Weight

Power supply

Model: T.62

452 (W) x 370 (D) x 87 (H) mm

6.3Kgs

AC 100V, 50/60Hz (For Japan)

AC 110V, 60Hz (For Taiwan)

AC 120V, 60Hz (For U.S.A., Canada, Mexico)

AC 220V, 50Hz (For United Arab Emirates, Chile, Argentina)

AC 220V, 60Hz (For Philippines)

AC 230V, 50Hz (For Europe, New Zealand, South Africa, Singapore, Israel)

AC 240V, 50Hz (For Australia, U.K.)

Power consumption

7.5W

WARRANTY & RETURN POLICY

Warranty

Through Stanton's authorized dealers around the World, Stanton, or one of Stanton's authorized distributors outside the U.S., will, without charge, repair or replace, at the sole discretion of the entity responsible for making the repair or providing the replacement, any Stanton merchandise proved defective in material or workmanship for a period of one year following the date of original purchase. Exceptions to this warranty are as noted below:

The warranty for mechanical parts which are subject to wear and tear are limited to the earlier of either thirty (30) days following the date of original purchase or the following number of cycles: Faders - 15,000; Rotary potentiometers - 10,000; and Switches - 10,000.

Stanton will warrant all replacement parts and repairs for ninety (90) days from the date of original shipment. Repairs made necessary by reason of misuse, alteration, normal wear, or accident are not covered under this warranty.

Returns

Authorized Stanton dealers are only authorized to sell and distribute merchandise within a specific country. All goods requiring warranty repair or replacement must be returned (freight prepaid if not hand-delivered) to the authorized Stanton dealer from whom the merchandise was purchased and in the same country where the merchandise was purchased. For purposes of purchases made via the Internet, the merchandise must be returned to the authorized Stanton dealer in the country where the authorized Stanton dealer which sold the merchandise to purchaser is located and not the authorized Stanton dealer in the country where the purchaser is located or the country in which the merchandise was received. Any returns to a non-authorized dealer or to an authorized Stanton dealer not in the same country as the merchandise was intended to be sold or as set forth above will void this warranty.

To initiate a warranty repair, you must contact the authorized Stanton dealer from whom you purchased the merchandise, and follow such authorized Stanton dealer's return policy.

Stanton assumes no risk and shall be subject to no liability for damages or loss resulting from the specific use or application made of the merchandise. Stanton's liability for any claim, whether based on breach of contract, negligence, infringement of any rights of any party, or product liability, and relating to the merchandise shall not exceed the price received by Stanton from your purchase of such merchandise. In no event will Stanton be liable for any special, incidental or consequential damages (including loss of use, loss of profit and claims of third parties) however caused, whether by the negligence of Stanton or otherwise. To the extent permitted by law and except as otherwise provided above, Stanton disclaims any express or implied warranties of merchantability or fitness for a particular purpose.

The above warranty provides you with specific legal rights. You may also have additional rights, which are subject to variation from state to state and country to country.

If there is a dispute regarding the warranty of merchandise that does not fall under the warranty conditions stated above, please include a written explanation with the merchandise when returned pursuant to the terms and conditions set forth herein.

Please register your product online at www.stantondj.com

Stanton Magnetics • 3000 SW 42nd Street • Hollywood FL 33312

Phone: +1 954.316.1500

Technical Support:
service@stantonmagnetics.com



Copyright © 2008 Stanton Magnetics, Inc.
DJLab, M.212, T.52, and T.62 are trademarks of the Stanton Group.
All other trademarks are property of their respective owners, who are not affiliated with Stanton DJ.
All information included in this User Manual is subject to change without notice.
www.stantondj.com - +1.877.578.6866